

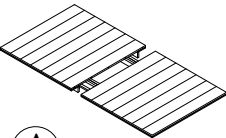

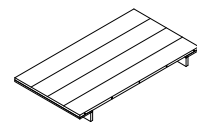

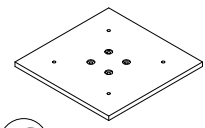
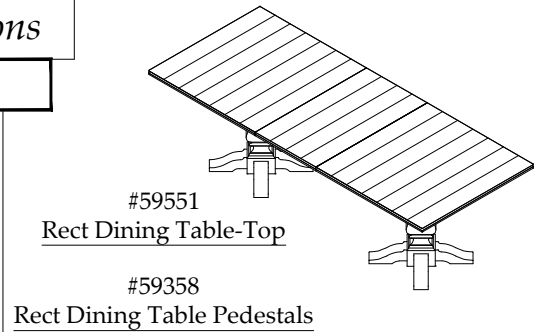

### Components packed with the #59551 Table Top

<p>Table Top</p>  <p><b>(A)</b> 1 set</p>	<p>Table Top Leaf</p>  <p><b>(B)</b> 1 pc.</p>	<p>Lower Bridge Panel</p>  <p><b>(C)</b> 2 pcs.</p>
--	---	--

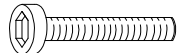
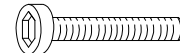

### Components & Hardware packed with the #59358 Table Pedestals

<p>Base Feet</p>  <p><b>(D)</b> 8 pcs.</p>	<p>Pedestal</p>  <p><b>(E)</b> 2 pcs.</p>	<p>M5/16"-18 x 3 " Long Allen Head Bolt</p>  <p><b>(F)</b> 16 pcs.</p>	<p>M5/16"-18 x 1-3/8 " Long Allen Head Bolt</p>  <p><b>(G)</b> 16 pcs.</p>	<p>5/16" Spring Washer</p>  <p><b>(H)</b> 32 pcs.</p>
<p>5/16"x19*2mm Flat Washer</p>  <p><b>(I)</b> 32 pcs.</p>	<p>5mm Allen Wrench</p>  <p><b>(J)</b> 1 pc.</p>	<p>Be sure to check all packing material carefully for small parts, which may have come loose inside the carton during shipment. To prevent possible scratches and damage, this furniture must be assembled by two people on a soft surface such as a blanket or carpet.</p>		

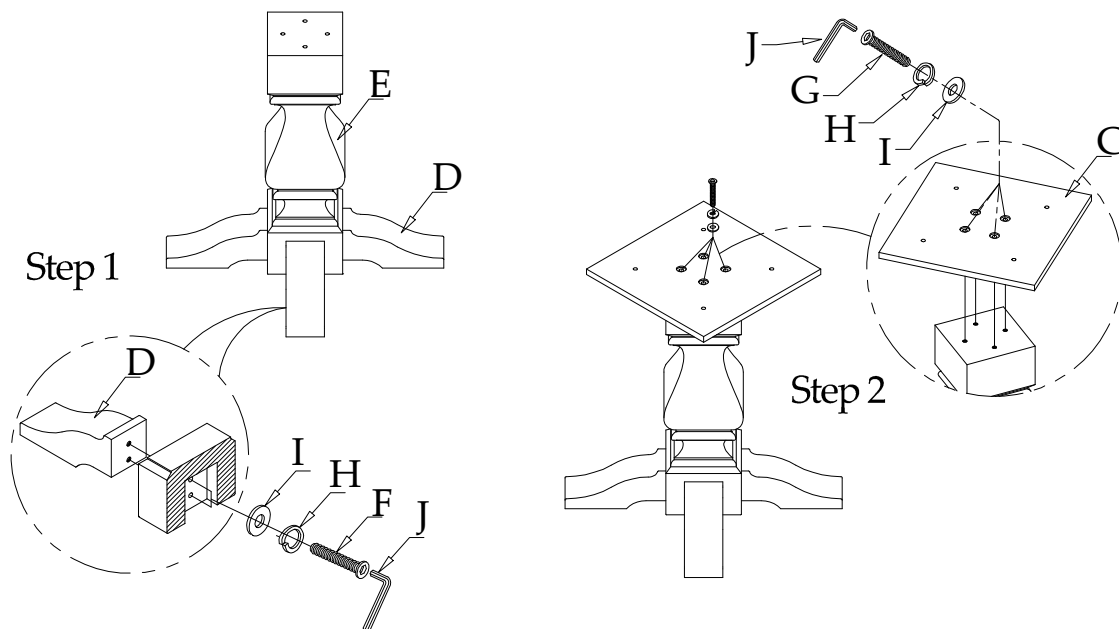

Step 1: Attach the Base Feet (D) at the bottom of the Pedestal (E) using the 3" Allen Head Bolts (F) Spring Washers (H) and Flat Washers (I) . Tighten using the Allen Wrench (J).

Step 2: Attach the Lower Bridge Panel (C) on top of the Pedestal (E) using the 1-3/8" Allen Head Bolts (G), Spring Washers (H) and Flat Washers (I). Tighten using the Allen Wrench (J).

## Adjustable leveler

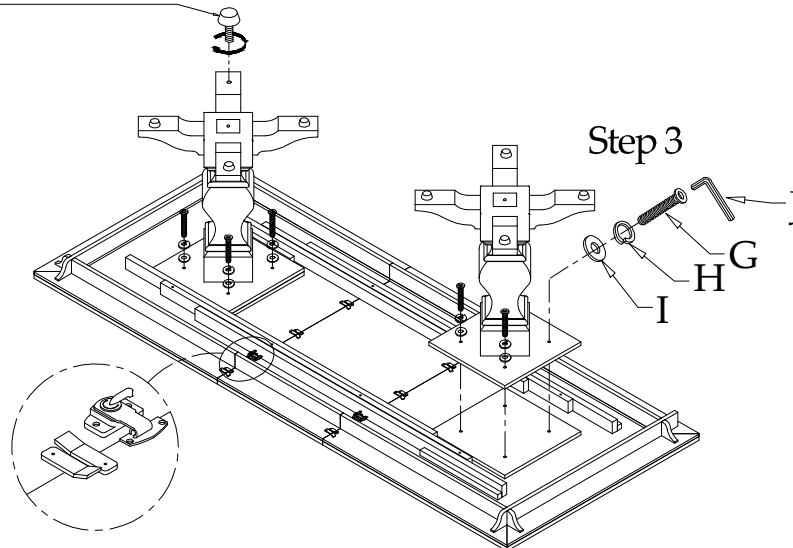

Step 3: With the Table Top placed upside down, position the assembled bases onto the bottom of the Table Top. Connect with the 1-3/8" Allen Head Bolts (G) and the same Washers as used in previous steps. Tighten with the Allen Wrench.

Step 4: Using two people, carefully set the assembled table upright.

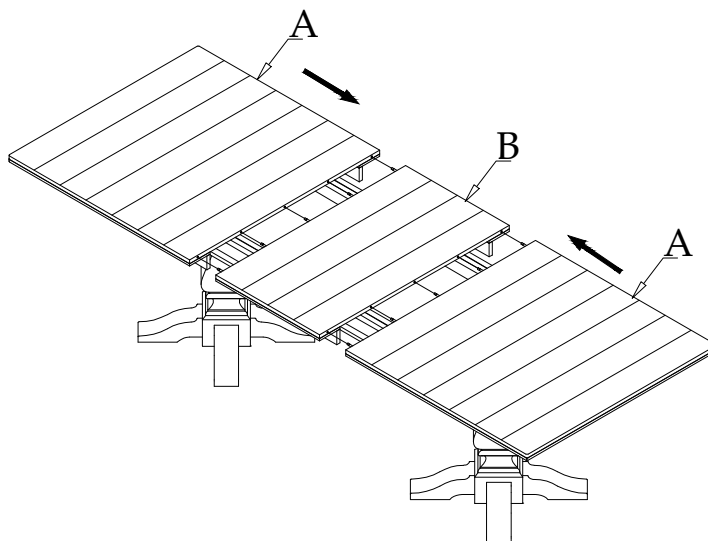

Step 5: To install the Table Top Leaf (B), reach underneath the sides of the Table Top and twist the handle of the Locks to unlock. Pull the two halves of the Table Top open, place the Leaf in position, aligning the pins with the holes on the edges and push the halves back together. Reach underneath the Table Top and relock.

To prevent undue stress on the Dining Table if it is moved, using two people, always lift and carry your Dining Table from one location to another.

